

Ketten-Etiketten

Labels for chains

Étiquettes pour chaînes

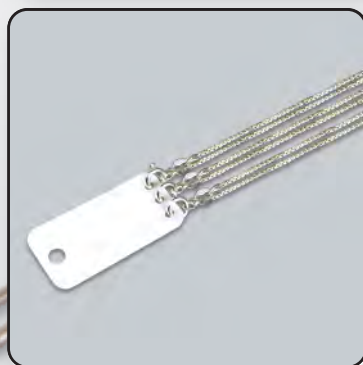

B Anzahl Bahnen
Number of rows
Nombre de poses

BB Bahnbreite
Width of row
Largeur de la bande

T Etikettenvorschub (Zoll)
Label feed (inch)
Avance des étiquettes (pouce)

* mit durchgestanzten Löchern
with punched holes
avec des trous entièrement percés

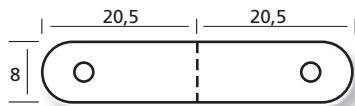

35 841* B = 1, BB = 60 mm

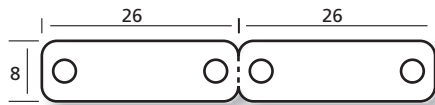

45 852 B = 1, BB = 100 mm, T = 3/6"

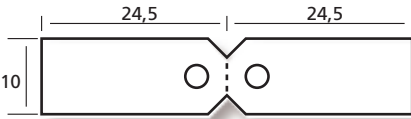

44 1049 B = 1, BB = 80 mm, T = 3/6"

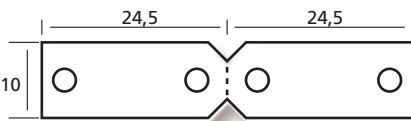

44 1049/1 B = 1, BB = 70 mm, T = 3/6"

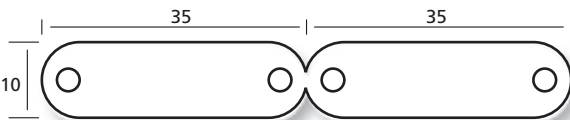

45 1070 B = 1, BB = 100 mm, T = 3/6"

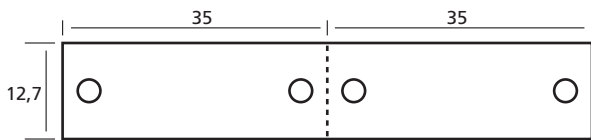

45 1270 B = 1, BB = 100 mm, T = 3/6"

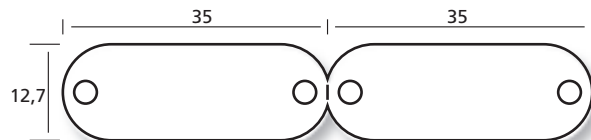

45 1270/1 B = 1, BB = 90 mm, T = 3/6"

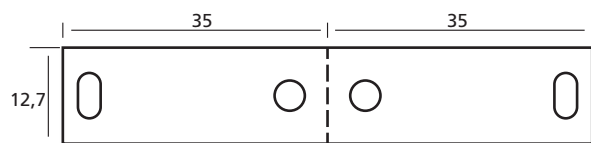

45 1270/3* B = 1, BB = 120 mm, T = 3/6"

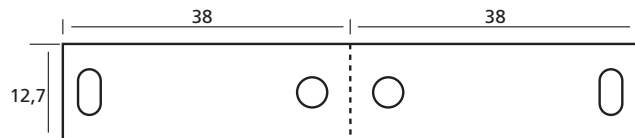

45 1276 B = 1, BB = 120 mm, T = 3/6"

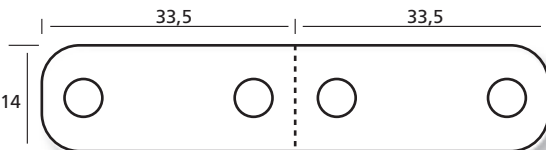

45 1467 B = 1, BB = 100 mm, T = 4/6"

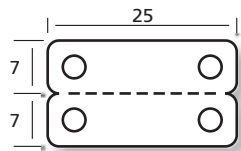

35 1425*

B = 2, BB = 80 mm
B = 1, BB = 40 mm

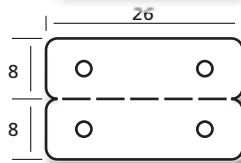

35 1626*

B = 1, BB = 60 mm
Lochabstand 20 mm

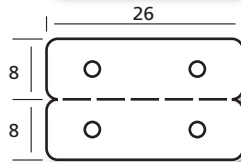

35 1626/1*

B = 1, BB = 60 mm
Lochabstand 16 mm

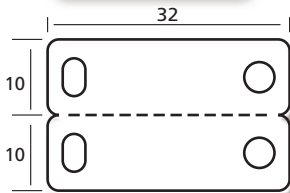

45 2032*

B = 1, BB = 60 mm, T = 6/6"
passend für KLING-Laden
suitable for KLING-trays
convient aux plateaux de KLING

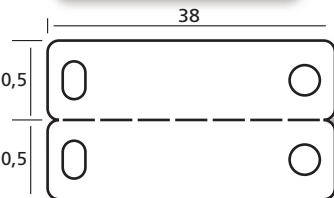

35 2138*

B = 2, BB = max. 110 mm

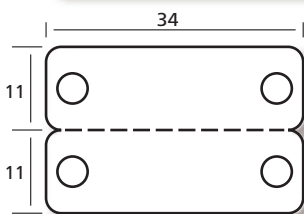

45 2234*

B = 2, BB = 120 mm, T = 6/6"

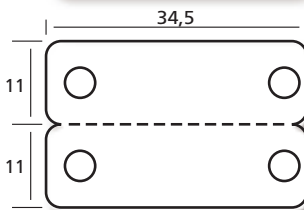

45 2235*

B = 2, BB = 120 mm, T = 6/6"

Lochabstand 1mm vom Rand
1 mm distance from hole
to margin

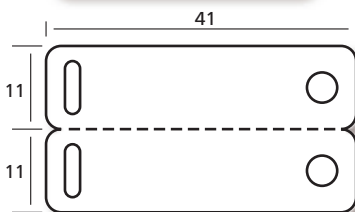

45 2241*

B = 2, BB = 110 mm, T = 6/6"

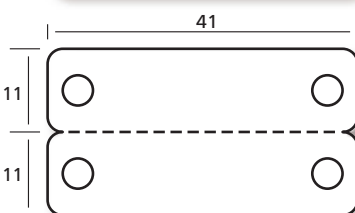

45 2241/1*

B = 1, BB = 80 mm, T = 6/6"

45 2241/2*

B = 2, BB = 100 mm, T = 6/6"

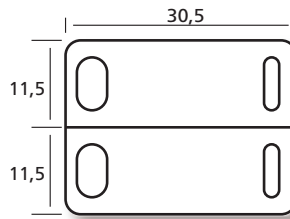

45 2330*

B = 3, BB = 120 mm, T = 6/6"

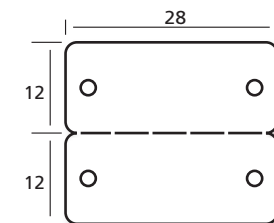

35 2428*

B = 1, BB = 40 mm

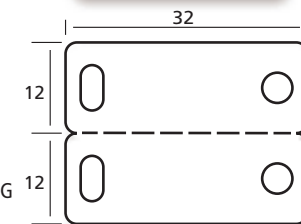

45 2432*

B = 1, BB = 60 mm, T = 7/6"

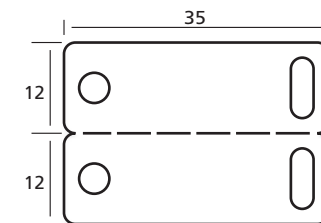

35 2435*

B = 2, BB = 100 mm

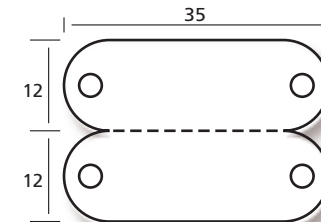

45 2435/1*

B = 2, BB = 100 mm, T = 6/6"

45 2435*

B = 1, BB = 60 mm, T = 6/6"

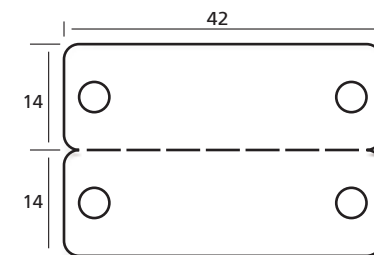

35 2842/1*

B = 2, BB = max. 110 mm

EAN-13

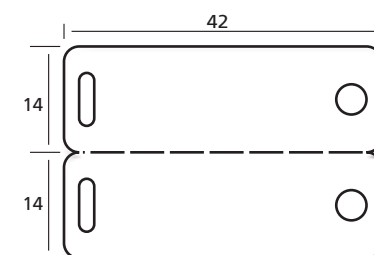

35 2842/2*

B = 2, BB = max. 110 mm

EAN-13

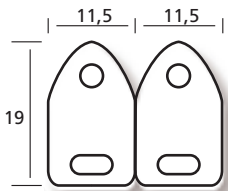

45 1923*
B = 4, BB = 130 mm, T = 6/6"

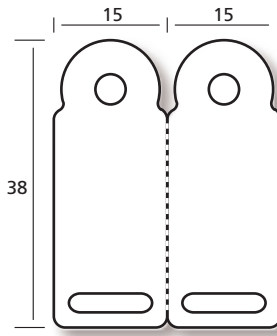

45 3830*
B = 2, BB = 100 mm, T = 12/6"

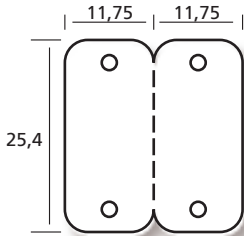

45 2524*
B = 1, BB = 60 mm, T = 6/6"

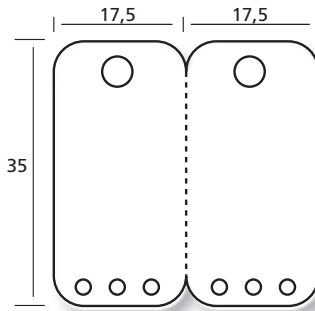

45 3535*
B = 1, BB = 60 mm, T = 9/6"

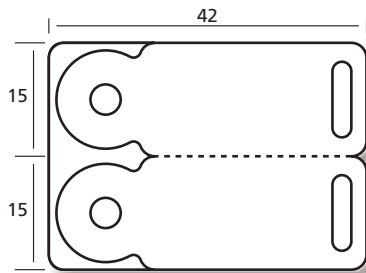

45 3042
B = 1, BB = 70 mm, T = 8/6"

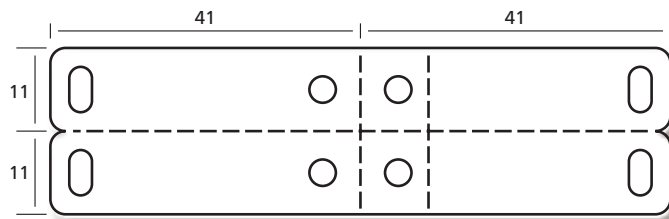

45 2282*

B = 1, BB = 100 mm, T = 6/6"

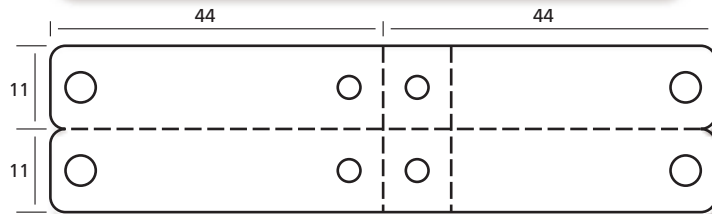

45 2288*

B = 1, BB = 120 mm, T = 6/6"

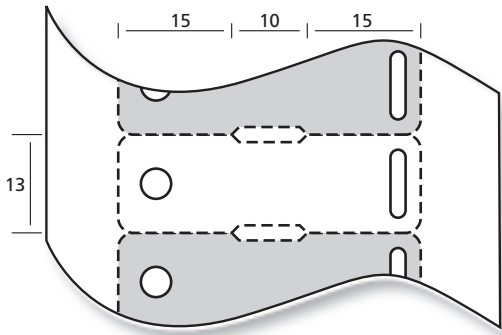

35 1340/2* B = 1, BB = 40 mm

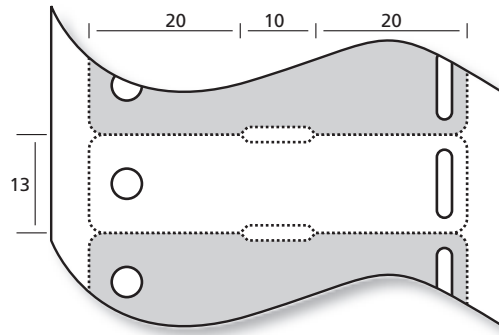

35 1350* B = 1, BB = 50 mm

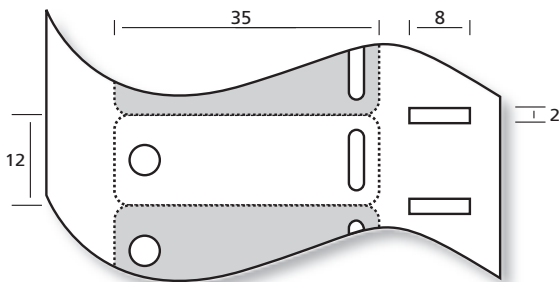

35 1235* B = 1, BB = 60 mm, T = Ø

Etikett mit mikroperforierter Kontur für nicht selbstklebende Papiere, Folien und Verbundfolie, mit Führungsloch für Thermotransfer-Drucker

Label with micro-perforated outline for non-adhesive papers, foils and compound foils with guide hole for thermotransfer printers

Etiquette à contours microperforés pour papiers, pellicules et composites non autocollants, avec trou de guidage pour imprimante transfert thermique

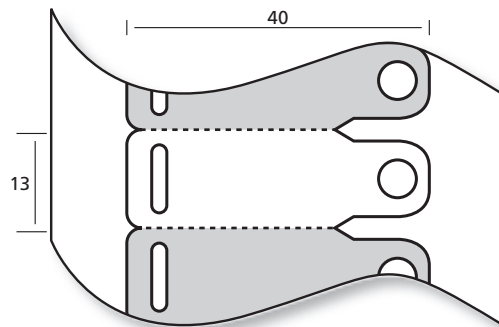

35 1340/1* B = 1, BB = 40 mm

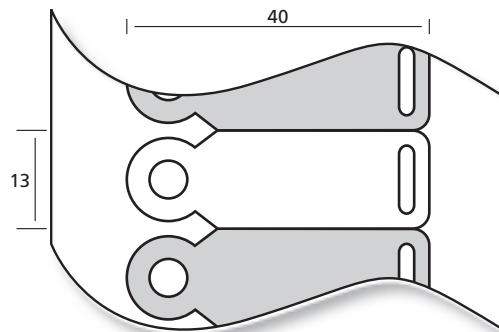

35 1340* B = 1, BB = 40 mm

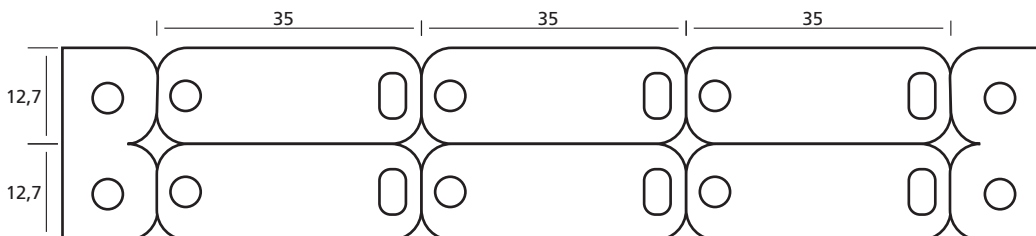

45 1335* B = 3, BB = 130 mm, T = 3/6",

für nicht selbstklebende Papiere, Folien und Verbundfolien
for non-adhesive papers, foils and compound foils
pour papiers, pellicules et composites non autocollants